

Скоба | **C1- ETD49**
 Clip

Материал | **Нержавеющая сталь**
 Material | **Stainless steel**

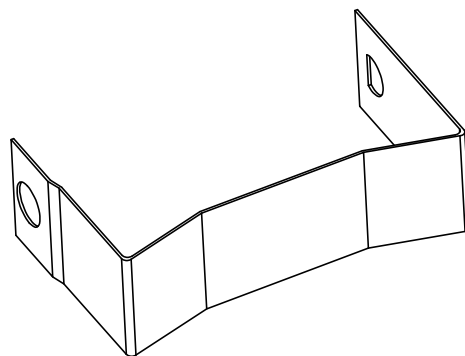
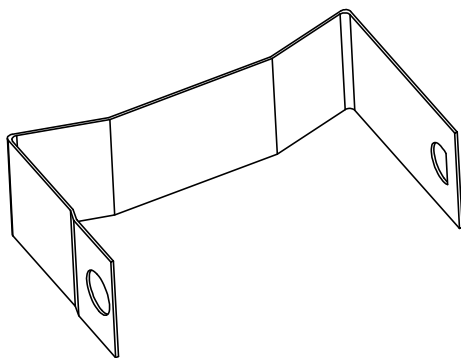
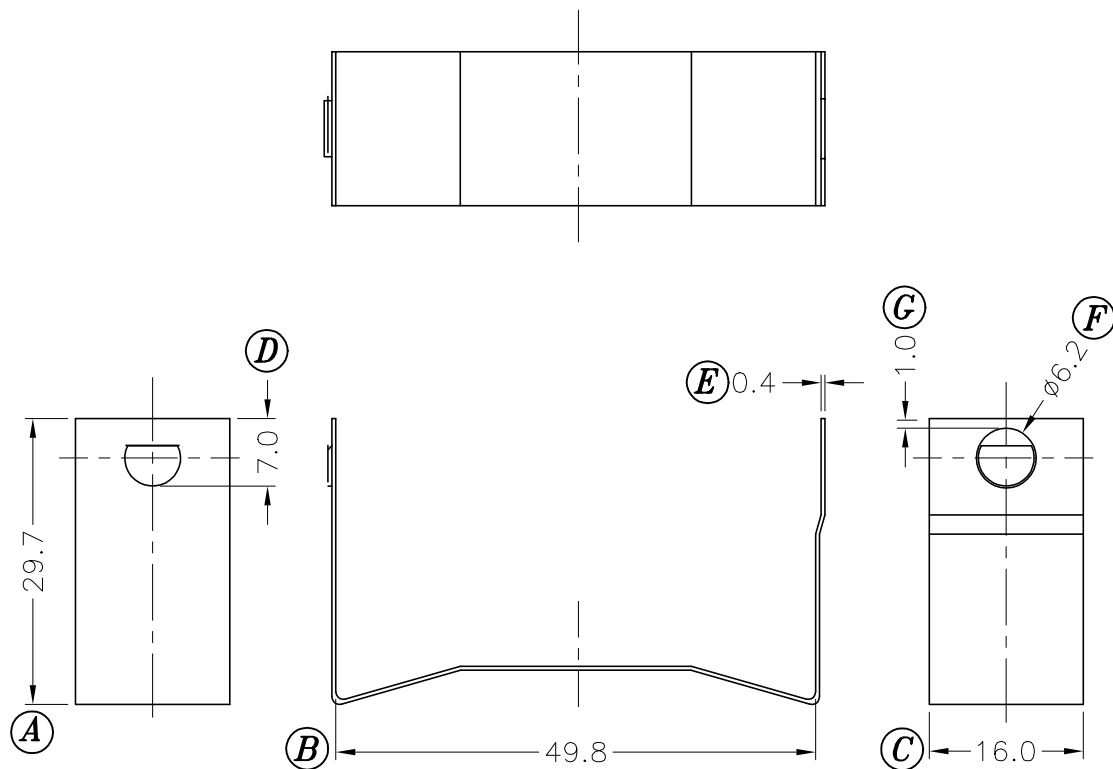

Допуски Tolerances	$0 < L \leq 4$	$\pm 0,1\text{mm.}$	Толщина Pin pitch	$\pm 0,2\text{mm.}$
	$4 < L \leq 16$	$\pm 0,2\text{mm.}$		
	$16 < L \leq 63$	$\pm 0,3\text{mm.}$		